

PD IR 4360-8

KNX - Deckeneinbau schwarz
EAN 4007841 086183
Art.-Nr. 086183

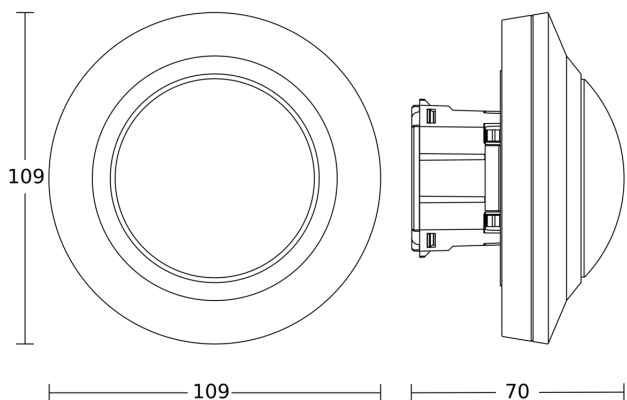

Maßzeichnung 1



Maßzeichnung 2

