

PD IR 4360-8

DALI-2 Input Device - Deckeneinbau weiß
EAN 4007841 085735
Art.-Nr. 085735

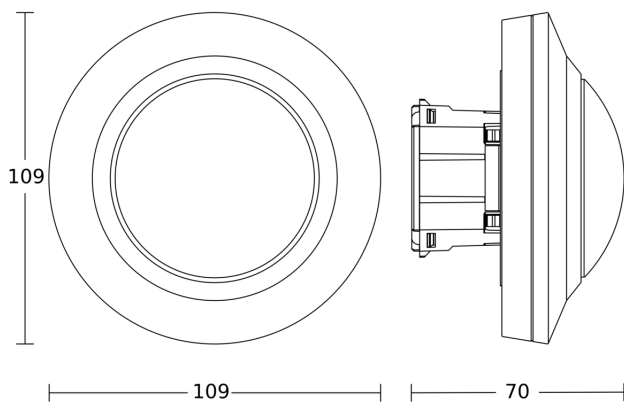

Maßzeichnung 1



Maßzeichnung 2

