

L 666 LED

V2 anthrazit

EAN 4007841 053116

Art.-Nr. 053116



Schaltplan Master

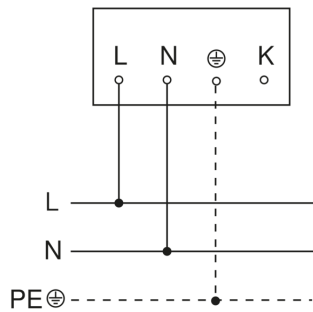

Schaltplan Master-Master Vernetzung

