

IS 3360

DALI-2 APC - Aufputz eckig
EAN 4007841 010560
Art.-Nr. 010560

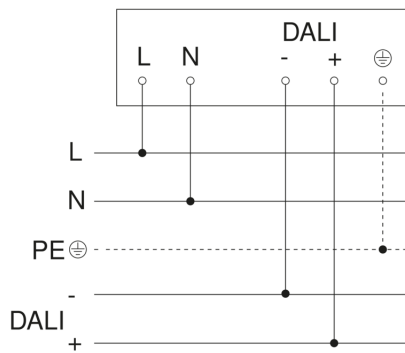

Schaltplan Master



Schaltplan Vernetzung DALI-2 APC mit DALI-2 IPD

