

Sensor-LED-Strahler - Professional Line

# XLED PRO 240 S

V2 warmweiß schwarz  
EAN 4007841 068110  
Art.-Nr. 068110



# XLED PRO 240 S

V2 warmweiß schwarz  
EAN 4007841 068110  
Art.-Nr. 068110

## Schaltplan Master

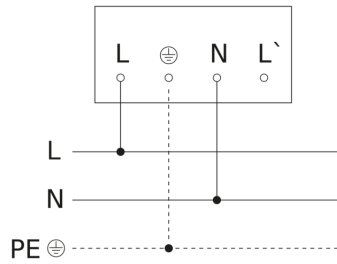

## Schaltplan Master-Master Vernetzung

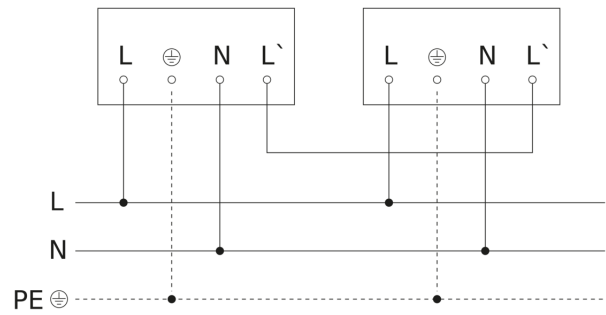

## Schaltplan Master-Slave Vernetzung

